







36 200 980

- Drehumstellung
- Rosette 60 x 60 mm



	Chrom	36 200 980-00
	Platin gebürstet	36 200 980-06
	Light Gold gebürstet	36 200 980-27
	Messing gebürstet (23kt Gold)	36 200 980-28
	Champagne gebürstet (22kt Gold)	36 200 980-46
	Champagne (22kt Gold)	36 200 980-47
	Dark Platinum gebürstet	36 200 980-99

Benötigtes Zubehör



- UP-Zweiwege-Umstellung -** 35 202 970 90
- Max. Einbautiefe 160 mm
 - Min. Einbautiefe 85 mm

36 200 980

mm [inches]

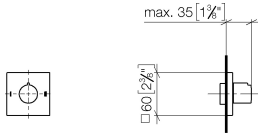

Durchflussdiagramm

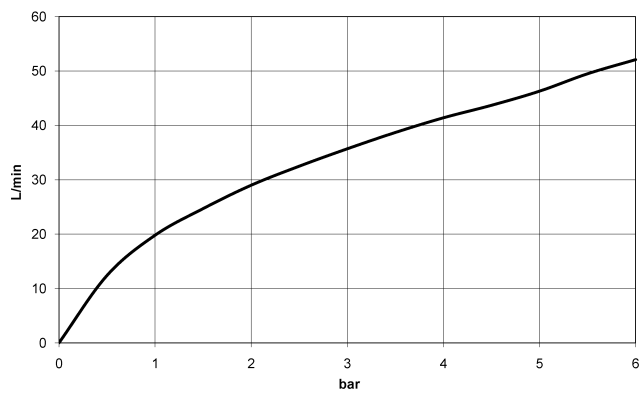

Zertifikate

LGA_38379.

WRAS_2307045.

36 200 980

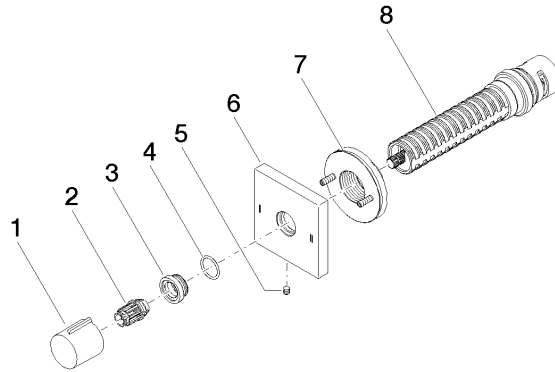

Ersatzteilstückliste

Nr.	Artikelnummer	Benennung	Verbaumenge	Lieferzeit
1	09 20 98 001-00	Griff	1	10
2	09 12 12 005 90	Rastbuchse	1	2
3	09 12 12 043-00	Aufnahme	1	10
4	09 14 10 017 90	Dichtung	1	2
5	09 31 11 294 90	Stift	1	2
6	09 27 98 037-00	Rosette	1	10
7	90 21 02 181 00 90	Scheibe	1	2
8	90 90 03 304 10 90	Umstellung	1	2